



TOILET PARTITIONS



WHY GLOBAL PARTITIONS

Global Partitions is the most widely specified manufacturer of Toilet Partitions in the industry. We have achieved this leadership position by providing the most complete line of toilet partitions for over five decades — powder coated steel, stainless steel, solid plastic, phenolic, color-thru phenolic and plastic laminate in four mounting styles.

Our innovative manufacturing which uses lean processes, continuous improvement programs and strategic purchasing practices, has allowed us to become the first company to ship four different materials — powder coated steel, stainless steel, black core phenolic and solid plastic – in 48 hours.

Our LEED-friendly products are versatile and have offered discerning designers and building owners peace of mind knowing that no matter their budgetary or stylistic needs, Global will provide the perfect solution.

Customer success is critical to our mission and we provide a value that exceeds price and an excellent service experience.

- **Speed** —15 colors powder coated, 18 colors solid plastic, 10 colors black core phenolic and satin stainless steel — all shipped in 48 hours
- **Broadest Selection in the Industry** — 6 materials and 4 mounting styles
- **Unparalleled Manufacturing Processes** — focus on quality and on-time delivery
- **Innovative Packaging** — GLO-GARD™ virtually eliminates freight damage
- **One Touch** — one point of contact for all your business needs
- **Customer-Focused Associates** — experts in every department
- **Choices** — Ultimate Privacy™, junior height and enhanced privacy with Global's no sight system
- **Recognized Performance** — Cowboys Stadium (Dallas), Wal-Mart, Dallas/Fort Worth International Airport, Dulles International Airport, Yankee Stadium, Goldman Sachs headquarters, Comcast headquarters, Fort Lewis Army Base, Michigan Stadium (University of Michigan), Home Depot, Chili's and Applebees

GLO-GARD™

Global Partitions is proud to introduce the finest packaging in partition shipping protection available — **GLO-GARD**. Regardless of whether the shipment contains two compartments or nine, your order is protected from the bumps and bruises normally associated with shipping.



FEATURES OF GLO-GARD PACKAGING:

- Internal dividers into which the partitions slide individually
- Additional padding to protect them from bumping into each other during handling and shipping
- Attached to a pallet and shrink wrapped

FASTTRACK — 48-Hour Shipping

Get 48-hour shipping on standard-sized, floor anchored/overhead braced SOLID PLASTIC (HDPE), POWDER COATED, BLACK CORE PHENOLIC or STAINLESS STEEL partitions.

HERE IS HOW IT WORKS:

- Place your order BEFORE NOON — www.globalpartitions.com/48hourfasttrack.
- Order any of the standard sizes in any of the standard solid plastic, powder coated or black core phenolic colors (see pages 6, 8 and 10 respectively) or #4 satin stainless steel.
- Your order will be produced, packed and ready to ship within 48 hours.

HOW TO ORDER

Use one of the following methods:

1. E-MAIL 1: Fill out the order form online and click submit to e-mail your order directly
2. E-MAIL 2: Save a copy of the order form, fill it out and email it back to 48hourfasttrack@globalpartitions.com
3. FAX: Save a copy of the form, fill it out and fax back to Global Partitions at 706.827.2710

Stainless Steel



Gleaming beauty indefinitely. The elegance of stainless steel complements any design scheme. Incorporates the known corrosion resistant benefits of type 304 stainless steel. Easily maintained, even scratches can be buffed out. Satin or textured finish. Available in all styles.

*Warranty 5 years**

Powder Coated



High-tech quality at an economical price. Thermoset hybrid powder finish on galvanized steel is highly resistant to corrosion, grease, acids, caustics, mars and stains. A broad range of contemporary colors to complement any interior. Available in all styles.

*Warranty 3 years**

Solid Plastic (HDPE)



Highly resistant to common cleaning agents as well as to moisture, mildew and graffiti. Ideal choice for busy public facilities and high humidity applications — never needs painting and will not easily dent, rust or delaminate. Available in a wide variety of colors and mounting styles. Floor Anchored/Overhead Braced, Ceiling Hung and Floor and Ceiling Anchored styles.

*Warranty 15 years**

Plastic Laminate



Combining design flexibility, aesthetic appeal and economy in an ideal finish — the proven benefits of high pressure laminates are built in — featuring a smooth surface highly resistant to scratches, grease and mars. Offered in a complement of designer colors. Available in all styles.

*Warranty 2 years**

Phenolic – Black Core



Holds up even under severe moisture conditions from showers, pools and saunas, or when maintenance includes hosing down toilet partitions. Ideal for where vandalism is a problem. In a full color spectrum — all with black edges. Available in all styles.

*Warranty 10 years**

Phenolic – Color-Thru



Color-Thru Phenolic lives up to its name, with surface color through and through. This product is impact, scratch and graffiti resistant. It also has excellent screw-holding power and all the advantages of traditional Phenolic performance. Available in all styles and attractive colors.

*Warranty 10 years**

GLOBAL STYLES

Floor Anchored/Overhead Braced

Clean lines, modern appearance and solidly braced for new construction or renovation, independent of floor condition. The unique pilaster construction combines with anti-grip head rail bracing for structural rigidity. Can be used with light weight concrete or wood floors.

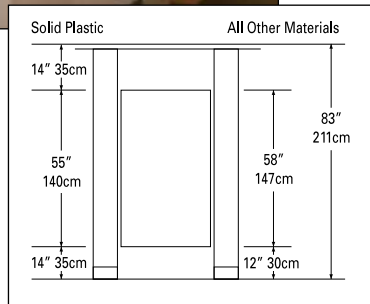
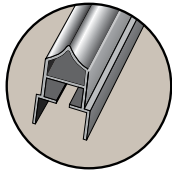

Ceiling Hung

Open design at the floor means easy access for better maintenance and reduced operating cost. Goes hand-in-hand with wall-hung fixtures for full floor accessibility. Proper installation requires attachment to structural ceiling support.

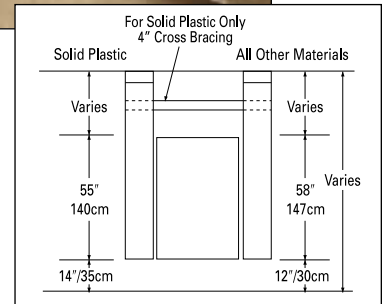

Floor Anchored

Perfect for low-ceiling washrooms. Sleek line across the top of partitions adds a modern accent. Design and construction ensure easy installation. For concrete floors only, this style requires 2" minimum penetration into floor. **Junior Height** sizes are available.

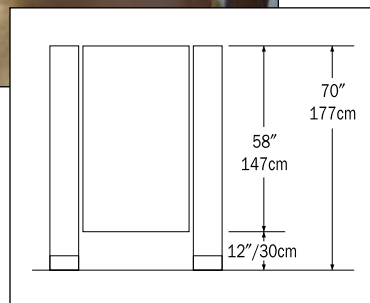

Floor and Ceiling Anchored

This construction style is extremely stable and durable and is recommended for busy washrooms where abusive treatment is prevalent and vandal resistance is critical. Requires concrete floor and structural ceiling supports.

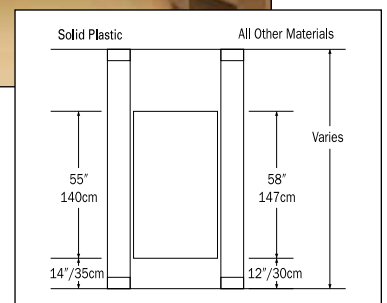

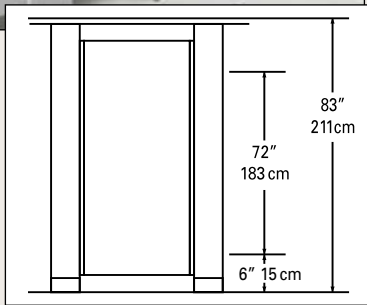

Ultimate Privacy™

Our Ultimate Privacy design features doors up to 72" tall and panels up to 75" tall, with No Sight hardware — full-height continuous stop and hinge side-filler — that eliminates sightlines into the compartments around the doors. Perfect for environments where additional privacy is desired. Ultimate Privacy compartments are available in four mounting styles.

Dressing Booths

Dressing Booths enhance shower installations — available with door or curtain options. Choose from solid plastic, phenolic, stainless steel or powder coated steel materials.



Privacy and Urinal Screens

Wall Hung Screens — Available in 3 standard heights: 42", 48" and 58"

Post-Mounted Screens — 1¾" sq. aluminum-post in Floor Mounted or Floor to Ceiling Mounted.

Pilaster-Mounted Screens — Available in Floor Mounted, Ceiling Hung, Floor to Ceiling or Overhead Braced.

POWDER COATED

Powder coated steel partitions provide high-tech quality at an economical price. The powder coated finish is electrostatically applied over galvanized steel. The finish is highly resistant to wear, fading, staining, scratching and scuffing. It is easily cleaned with mild soap and wiped dry.

The steel is electrogalvanized to protect against corrosion and provide a proper base for the finish. The face sheets are held rigid and permanently in place by an interlocking strip welded at each corner. The core is cellular honeycomb which provides strong construction and maximum sound attenuation.

Global Partitions offers a full color palette of popular colors for design flexibility.

FASTTRACK: 48 Hour Shipping

Available in all standard colors shown below
— Floor Anchored/Overhead Braced.



COLOR SELECTION:

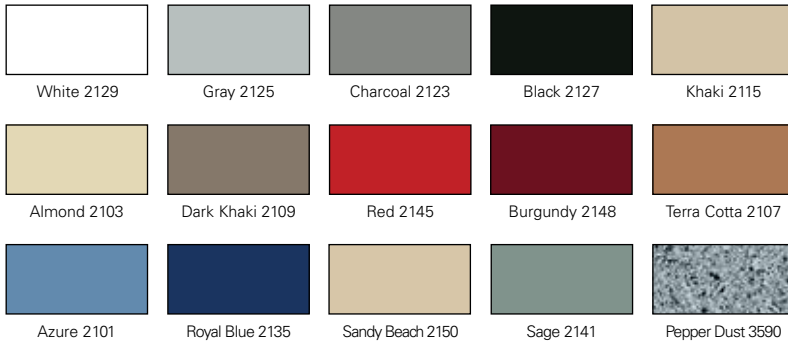

OPTIONS:

- Wood Core
- Continuous Aluminum Brackets
- Continuous Stainless Steel Brackets
- Continuous Powder Coated Brackets
- Continuous Stainless Steel Hinge
- No Sight Hardware
- Ultimate Privacy™ Height Options
- Stainless Steel Stirrup Brackets & Door Hardware



CONSTRUCTION FEATURES:

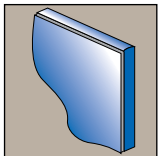

Welded Corner
Corners of panels, pilasters and doors are welded to each other and to the adjacent face sheets.

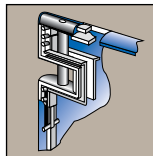

Upper Door Bracket
Internal part of the door. A pin goes through door and bracket for three-point bearing and operates in a nylon bushing in upper hinge bracket.

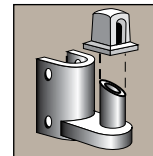

Bottom Door Hinge
Gravity-positioning hinge provides safe, durable and maintenance free support.

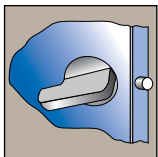

Concealed Latch
With emergency access and ADA lever handle.

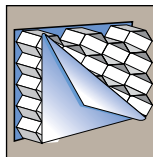

Honeycomb Core
Made of cellular honeycomb. This type of core provides strong construction and sound attenuation.

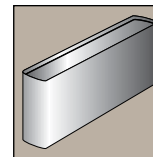

Shoe Construction
One-piece stainless steel, type 304, with #4 satin finish trim shoes are hemmed top and bottom for rigidity and sleek appearance.

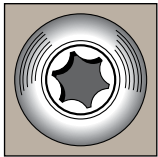

Vandal-Resistant Fasteners
Special driver installs fasteners which virtually eliminates unauthorized removal and ensures easy installation.

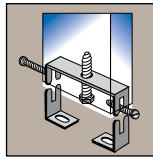

Pilaster Mounting
Pilaster adjustments, with floor-mounted jack-leveling device is standard on floor anchored/overhead braced pilasters.

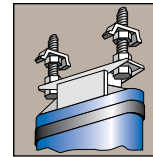

Alternate Pilaster Mounting
This heavy gauge mounting is furnished on all ceiling hung and floor anchored pilasters.

Stainless steel toilet partitions are virtually indestructible and retain their gleaming beauty indefinitely. These units combine the strength of #304 stainless steel with a #4 satin finish or textured finish, formed and bonded to a honeycomb core. The face sheets are held rigid and permanently in place by an interlocking strip welded at each corner.

Stainless steel components are impervious to just about any substance. Even scratches caused by deliberate vandalism can be removed by buffing. The elegance of Global Partitions stainless steel components complements any design scheme, either in new construction or for renovations.

FAST TRACK: 48 Hour Shipping
Available in #4 Satin Finish
— Floor Anchored/Overhead Braced.



OPTIONAL FINISH SELECTION:

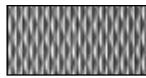

Diamond Finish



Leather Finish



CONSTRUCTION FEATURES:

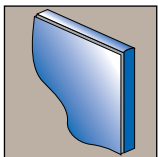

Welded Corner

Corners of panels, pilasters and doors are welded to each other and to the adjacent face sheets.

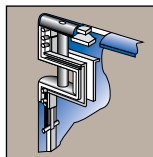

Upper Door Bracket

Internal part of the door. A pin goes through door and bracket for three-point bearing and operates in a nylon bushing in upper hinge bracket.

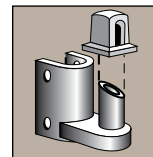

Bottom Door Hinge

Gravity-positioning hinge provides safe, durable and maintenance free support.

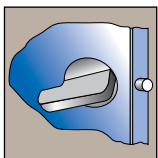

Concealed Latch

With emergency access and ADA lever handle.

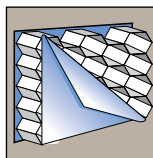

Honeycomb Core

Made of cellular honeycomb. This type of core provides strong construction and sound attenuation.

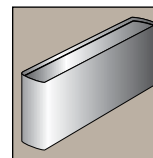

Shoe Construction

One-piece stainless steel, type 304, with #4 satin finish trim shoes are hemmed top and bottom for rigidity and sleek appearance.

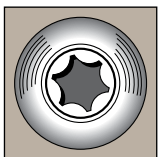

Vandal-Resistant Fasteners

Special driver installs fasteners which virtually eliminates unauthorized removal and ensures easy installation.

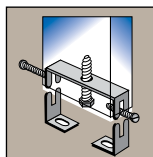

Pilaster Mounting

Pilaster adjustments, with floor-mounted jack-leveling device is standard on floor anchored/overhead braced pilasters.

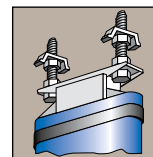

Alternate Pilaster Mounting

This heavy gauge mounting is furnished on all ceiling hung and floor anchored pilasters.

OPTIONS:

- Wood Core
- Continuous Aluminum Brackets
- Continuous Stainless Steel Brackets
- Continuous Stainless Steel Hinge
- No Sight Hardware
- Ultimate Privacy™ Height Options
- Stainless Steel Stirrup Brackets & Door Hardware

SOLID PLASTIC (HDPE)

Solid plastic toilet partitions are the ideal choice for high-traffic areas as well as high-humidity applications and corrosive environments. They are environmentally safe and sanitary, never need painting and will not easily dent, rust or delaminate. With a textured finish to hide the effects of vandalism, it is the low maintenance material of choice as minor scratches can often be repaired.

The High Density Polyethylene (HDPE) panels are virtually impenetrable by water, odor, mildew and soap and most commercial cleaning agents will not damage the surface.

Five of the most popular colors are now available in 100% post-consumer material.

These partitions have passed all five parameters of the NFPA 286 fire test criteria.

FAST TRACK: 48 Hour Shipping

Available in all standard colors shown below in Pebble Grained finish only — Floor Anchored/Overhead Braced.



COLOR SELECTION:

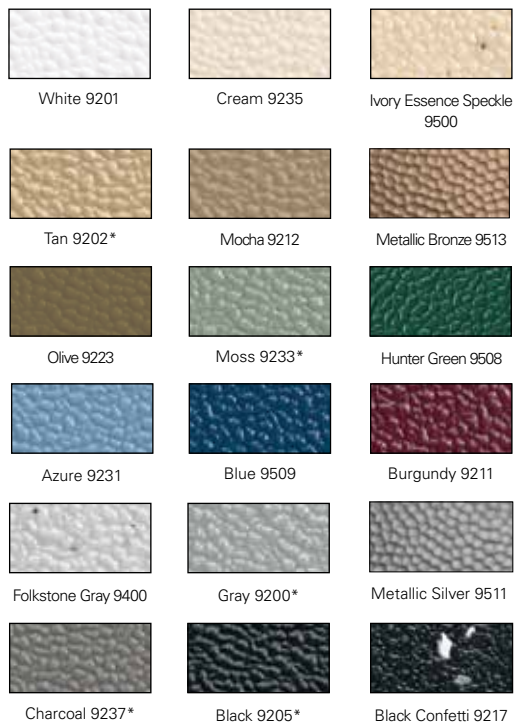

* Available in 100% post-consumer recycled material

OPTIONS:

- Continuous Stainless Steel Brackets
- Continuous Aluminum Brackets
- Continuous Plastic Brackets
- Continuous Stainless Steel Hinge
- Integral Hinge
- Vault Hinge
- Anti-Microbial Additives
- No Sight Hardware

CONSTRUCTION FEATURES:

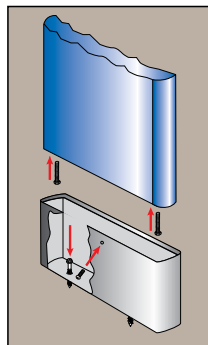

Easy-Stall Shoe

- For floor anchored overhead braced
- Easily adjusted leveling bolt
- True concrete anchor screws designed for lasting holding power
- Anchor rated at 2770 lbs. pullout strength

For use with Type 304 stainless steel or plastic mounting shoe



Plastic Mounting Shoe

For Easy-Stall Shoe

Available in:

- Cream 9235
- Blue 9509
- Metallic Silver 9511
- Black 9205

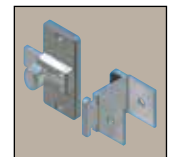

Emergency Access

Meets ADA requirements. Slotted keeper coupled with gravity hinges allows access in an emergency.

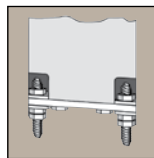

Floor Stud Mounting System

Heavy-duty 5/16" diameter mounting studs adjust height and level pilasters by turning the locknut adjusters. For use with stainless steel shoe.

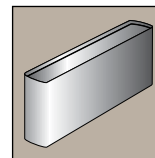

Stainless Steel Shoe

For floor stud mounting system

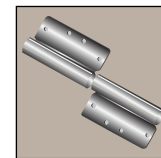

8" Aluminum Wrap-Around Hinge

Mainstream choice.

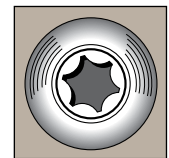

Vandal-Resistant Fasteners

Special driver installs fasteners which virtually eliminates unauthorized removal and ensures easy installation.

AVAILABLE FINISHES:



Pebble Grained
Available in all non-metallic colors



Tough Texture™ (TT)
Available in all non-speckled colors with additional lead time

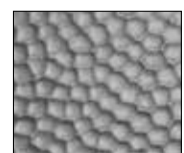

Hammered
Stocked in silver and bronze. Available in all non-speckled colors with additional lead time.

PLASTIC LAMINATE

Plastic laminate partitions combine design flexibility with affordable cost. The high pressure laminate finishes, bonded under pressure to a solid impact-resistant particle board core, meet or exceed all NEMA standards. Edge banding of all components prior to face lamination ensures optimum water runoff and durability.

Plastic laminate is available in all four installation styles and a variety of designer colors to complement vanities and counter tops. They are the finish of choice for commercial and institutional installations where aesthetics are essential.



COLOR SELECTION:

Mission White 1010	Almond 4000	Sand 4010	Khaki Brown 4040	Taupe 9096	White Carrara 1100	Crisp Linen 1150	Neutral Glace 1130
Western Suede 4110	Cream Fizz 4100	Natural Canvas 4410	Desert Zephyr 4583	Casual Linen 4538	Midway 4536	Natural Tigris 4611	Tungsten Ev 4801
Western Bronze 4120	Burnished Chestnut 9176	Windswept Bronze *9292	Walnut Quarstone 9100	Seed 3200	Possum 6100	Beluga Beige 9208	Autumn Indian 9150
Crayon 7600	Aqua Fizz 7100	Brittany Blue 7010	Navy Grafix 7318	Silver Gray 3000	Dove Gray 3010	Folkstone Celesta 3300	Canyon Zephyr 3713
Pearl Soapstone 3500	Windswept Pewter *3849	Storm Solidz 3542	Graphite Grafix 3020	Arcade 7500	Smoke Quarstone 3350	Graphite 2150	Black 2000
Maple *9918	Cherry *9954	Mahogany *9939	Ebony *9500	Asian Night *9550			

* Directional Pattern — pattern on panels over 60" wide will run perpendicular to pattern on doors and pilasters

CONSTRUCTION FEATURES:

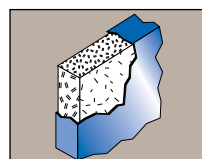

Core
Particle board core is 45# density to resist warping and ensure a smooth surface.

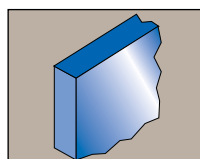

Edge Construction
Face laminate overlaps edge laminate to ensure water runoff and resists vandalism.

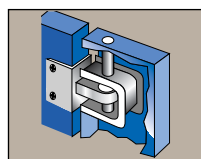

Door Hinges
Full weight-bearing hinges on both top and bottom of each door. Wrap-around mounting and through bolting for vandal resistance.

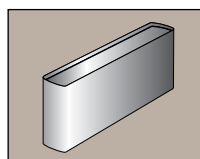

Shoe Construction
Stainless steel, type 304, with #4 satin finish trim shoes are hemmed top and bottom for rigidity and sleek appearance.

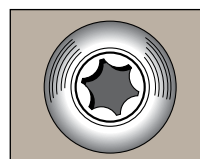

Vandal-Resistant Fasteners
Special driver installs fasteners which virtually eliminates unauthorized removal and ensures easy installation.

OPTIONS:

- Steel Core Pilasters
- Plywood Core
- Continuous Aluminum Brackets
- Continuous Stainless Steel Brackets
- Continuous Stainless Steel Hinge
- Stainless Steel Stirrup Brackets & Door Hardware

PHENOLIC – BLACK CORE

Phenolic partitions are the material of choice where durability and strength are required. These partitions are fabricated to stand the test of time. The dense components, combined with stainless steel brackets and fasteners, stand up to the most extreme conditions of moisture and humidity. Phenolic is impact, water and corrosion resistant, and does not support bacteria.

The phenolic partition is decoratively faced on both sides as an integral part of a resin-impregnated kraft paper core. The surface and core sheets are fused at high temperature and pressure. In addition to strength and serviceability, a wide range of colors provides limitless design flexibility. Phenolic partitions are available in all four installation styles.



FAST TRACK: 48 Hour Shipping

Available in all standard colors shown below
— Floor Anchored/Overhead Braced.

COLOR SELECTION:



Almond 4000



Neutral Glace 1130

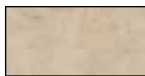

Natural Canvas 4410



Desert Zephyr 4583



Tungsten EV 4801



Taupe 9096

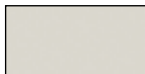

Silver Gray 3000



Folkstone Celesta 3300



Dove Gray 3010



Graphite Grafix 3020

CONSTRUCTION FEATURES:

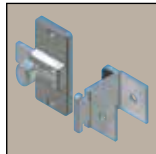

Emergency Access

Meets ADA requirements. Slotted keeper coupled with gravity hinges allows access in an emergency.

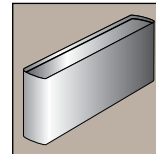

Shoe Construction

Stainless steel, double-hemmed, trim shoe with #4 satin finish conceals mounting fasteners and hardware.

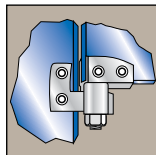

Vault Hinge

Rugged, attractive wrap-around hinge. Extra strong for heavy-duty installations.

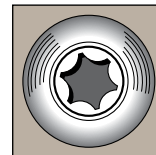

Vandal-Resistant Fasteners

Special driver installs fasteners, virtually eliminating unauthorized removal, and ensuring easy installation. Stainless steel fasteners are standard for phenolic partitions.

OPTIONS:

- **Class "A" Fire Rated Material**
- **Continuous Stainless Steel Hinge**
- **Continuous Stainless Steel Brackets**
- **Continuous Aluminum Brackets**
- **No Sight Hardware**

PHENOLIC – COLOR-THRU

Color-Thru Phenolic provides another reason to choose phenolic. True to its name, Color-Thru is made with surface color through and through, to help resist damage; and even discourage vandalism and abuse. Along with phenolic strength, durability and low maintenance requirement, Color-Thru Phenolic is impact, scratch and graffiti resistant. It has excellent screw-holding power and all the advantages of traditional Phenolic performance.

Same construction features and hardware as Black Core Phenolic.



COLOR SELECTION:

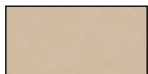

Hazelnut 4450C



Cinnamon 5450C

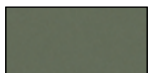

Sage 6450C



Persian Blue 7450C



Gray Mist 3450C



Black 2000C

CONSTRUCTION FEATURES:

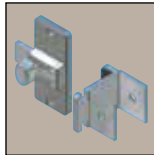

Emergency Access
Meets ADA requirements. Slotted keeper coupled with gravity hinges allows access in an emergency.

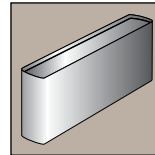

Shoe Construction
Stainless steel, double-hemmed, trim shoe with #4 satin finish conceals mounting fasteners and hardware.

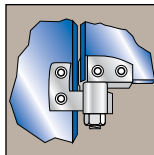

Vault Hinge
Rugged, attractive wrap-around hinge. Extra strong for heavy-duty installations.

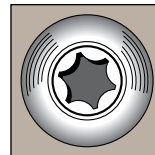

Vandal-Resistant Fasteners
Special driver installs fasteners, virtually eliminating unauthorized removal, and ensuring easy installation. Stainless steel fasteners are standard for phenolic partitions.

OPTIONS:

- **Continuous Stainless Steel Brackets**
- **Continuous Aluminum Brackets**
- **Continuous Stainless Steel Hinge**
- **No Sight Hardware**

MATERIAL SELECTION GUIDE

	POWDER COATED STEEL	STAINLESS STEEL	
APPLICATION			
Fire Rating; Standard (Optional*)	A	A	
Vandal Resistance	★ ★	★ ★ ★	
Ease of Maintenance	Average	Average	
Wet Area Suitability	Low	Low	
RELATIVE COST (Powder = 100%)	100%	260%	
WARRANTY	3 Years	5 Years	
COLOR / FINISH OPTIONS	15 Standard Colors	Type 304 with #4 brush finish (Texture patterns also available)	
MOUNTING STYLES ◆ = Available			
Floor Anchored/Overhead Braced	◆	◆	
Floor Anchored	◆	◆	
Ceiling Hung	◆	◆	
Floor and Ceiling Anchored	◆	◆	
Ultimate Privacy	◆	◆	
HARDWARE ◆ = Standard ◇ = Optional			
STIRRUP BRACKETS			
Chrome Plated Zamac	◆	◆	
Stainless Steel	◇	◇	
Aluminum			
CONTINUOUS BRACKETS			
Stainless Steel	◇	◇	
Aluminum	◇	◇	
Plastic			
HINGES			
Recessed/ Notched (Chrome Plated Zamac)	◆	◆	
Recessed/ Notched (Stainless Steel)	◇	◇	
8" Aluminum Wrap-Around			
Vault (Brushed Zamac)			
Vault (Brushed Stainless Steel)			
Integral			
Continuous Stainless Steel Hinge	◇	◇	
SHOES			
Stainless Steel 3" High	OB	OB	
Stainless Steel 4" High	FM, CH, FC	FM, CH, FC	
Stainless Steel 5" High			
CONSTRUCTION			
Door Thickness	1"	1"	
Panel Thickness	1"	1"	
Pilaster Thickness	1¼"	1¼"	
Urinal Screen Thickness	1"	1"	

* Available at Additional Cost

MATERIAL SELECTION GUIDE

	SOLID PLASTIC (HDPE)	PLASTIC LAMINATE	COLOR-THRU PHENOLIC	BLACK CORE PHENOLIC
	NFPA 286 / B	C	B	B (A)
	★★★★★	★★	★★★★★★	★★★★★★
	High	Average	High	High
	High	Low	High	High
	205%	120%	300%	230%
	15 Years	2 Years	10 Years	10 Years
	18 Standard Colors	45 Standard Colors	6 Standard Colors	10 Standard Colors
	◆	◆	◆	◆
		◆	◆	◆
	◆	◆	◆	◆
	◆	◆	◆	◆
		◆		
	◇	◇	◆	◆
	◆			
	◇	◇	◇	◇
	◇	◇	◇	◇
	◇			
		◆		
		◇		
	◆			
	◇		◆	◆
	◇		◇	◇
	◇			
	◇	◇	◇	◇
	OB			
	CH, FC			
	CH, FC	OB, FM, CH, FC	OB, FM, CH, FC	OB, FM, CH, FC
	1"	1"	¾"	¾"
	1"	1"	½"	½"
	1"	1¼"	¾"	¾"
	1"	1"	½"	½"

OB - Floor Anchored/Overhead Braced FM - Floor Mounted/Anchored CH - Ceiling Hung FC - Floor and Ceiling Hung

GLOBAL PARTITIONS

SPECIFICATIONS:

Complete specifications or additional information, can be found on our website: globalpartitions.com.

COLOR DISCLAIMER:

The color charts shown in this catalog are printed reproductions and are for descriptive purposes only. Color selection cards are available upon request. Global Partitions reserves the right to change specifications and products without notice.



ADA CODE REQUIREMENTS:

Global Partitions has been a pioneer in the design of facilities for the physically challenged. Our engineers stand ready to assist in layout design to meet code or special requirements.

WARRANTY:

Individual warranty descriptions for each of the partition materials that Global sells are available for download at globalpartitions.com.

THE ASI GROUP

Global Partitions is a part of The ASI Group. The ASI Group is your single source solution for Washroom Accessories, Toilet Partitions, Lockers and other storage products worldwide.

Our mission is to make our customers successful by providing value that exceeds price and an excellent service experience. We do this by providing superior design, the broadest range of quality products in the industry, and state-of-the-art manufacturing to ensure that we have whatever our customers need, whenever they need it.

With experienced architectural representatives and customer service teams, we are here to help you deliver on projects that range from world-class office buildings, educational facilities, sports venues, and government buildings to hospitals, chain stores, and hospitality / entertainment complexes.

Visit Global Partitions' affiliated companies, American Specialties, Inc. and ASI Storage Solutions, for all your washroom and storage needs.



americanspecialties.com



asistorage.com



ASI Group is committed to doing our part in saving our planet –
The Footprint We Make Matters!



Global Partitions
2171 Liberty Hill Road, Eastanollee, GA 30538
Tel: 706.827.2700 Fax: 706.827.2710
E-mail: sales@globalpartitions.com Web: globalpartitions.com

Distributed by: